

PREMIER SIPS

STRUCTURAL INSULATED PANELS

BY *INSULFOAM* A *CARLISLE* Company

Stronger. Straighter. Greener.

Installation Guide



Suggested guidelines for the
preparation and installation of
Premier Structural Insulated Panels

Introduction

Premier SIPs' Installation Guide has been divided into convenient sections covering most aspects of Premier SIPs installation. Designed for carpenters, framers, contractors and do-it-yourselfers, the instructions and detailed illustrations will give you the basics of building with Premier SIPs at just a glance.

Premier SIPs' installation techniques are based on Premier SIPs' continuing program of independent, third-party testing and more than 30 years of fabrication, installation, and innovation.

If you have questions about anything covered in this installation guide, please call us and ask to speak with a technical representative. A listing of Premier's office phone numbers appears in the back of this guide.

PREMIER
 **SIPS** Stronger.
Straighter.
Greener.

BY **INSULFOAM** A **CARLSLE** Company

Table of Contents

Premier SIPs Tips	4
Storage & Handling.....	6
Checklist of Tools	7
Spline Connection	8
Lumber Connection.....	9
I-Joist Connection.....	10
Panel Basics – Assembly.....	11
Fasteners	12
Field Fabrication	12
Fabrication Rake/Gable Walls	14
Floors	15
Sill Plates	18
Walls.....	20
Headers	24
Intermediate Floors.....	26
Roofs	28
Insul-lam	32
Electrical	33
Plumbing.....	35
Shearwalls	36
R-Values	37
Panel Weight (Psf).....	37
Load Values	38

Premier SIPs Tips

- Fill all voids with expanding foam.
- Project must meet local code.
- Confirm your installation date at least two weeks prior to requesting on-site assistance.
- Schedule a preconstruction meeting with your installation crew (concrete, plumbing, electrical, siding, roofing, etc.).
- Inventory materials when you receive them.
- Check all SIPs for proper cuts and recesses.
- Double check SIPs sizes and compare to shop drawings before installation.
- Engineered details take precedence over Premier SIPs details.
- Premier SIPs details regarding mastic and SIPs tape need to be followed.
- Any changes required at the job site should be communicated with the technical representative.
- Make sure your foundation or floor is level and square.
- Fabricate and pre-install dimensional or I-joist spline material as specified.

-
- Review engineering for hold downs if applicable.
 - Make sure to pre-drill the top and bottom plates for the vertical electrical chases in the wall panels.
 - Do not put plumbing inside SIPs.
 - Do not cut the skins (OSB) for extra electrical chases or plumbing.
 - Do not pick up the SIPs by the edge of the top skin.
 - Remove debris from sill plate before you place the SIP wall panel on it.
 - Use mastic on all connections as shown in the PBS details.
 - Make sure that both of the wall SIPs skins are bearing on the floor.
 - Follow proper nailing requirements according to details and job specific engineering.
 - Plumb each SIP in each direction, then secure with nails.
 - Do not apply interior or exterior materials over wet SIPs.

Storage & Handling

Your panels will usually arrive on a flatbed truck. Depending on the site, panels should be off-loaded to a clean, flat area with sufficient maneuvering room. (A fork-lift will speed the off-load process.)

Panels do not come in any particular order. This allows for minimized shipping costs by taking full advantage of the space available on the truck. It is advisable to sort the panels as you off load them. This process will require room to shift and stack the panels accordingly.

Sort and stack all of the panels by panel ID number and move them as close to their final location as possible. Place at least three stickers a maximum of 4' on center (o.c.) under the panel stacks to ensure that the panels remain flat. The stickers should be a minimum of 3 ½" wide.

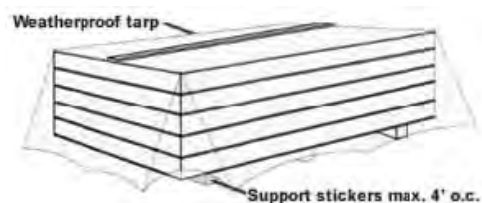

Inventory the panels as you off-load them. If one is missing or damaged call Premier SIPs immediately. We will work to correct the problem as soon as possible.

Remember, you are working with a wood product that may swell after prolonged exposure to moisture. Keep all panels and accessories protected from the elements prior to installation. If splines swell, installation may be hampered.

Checklist of Tools

- One or two 29 oz. caulking guns
- Hand saw
- Pry bars
- Sledge hammers
- Mineral spirits
- String line
- Lifting eyebolts
- Lifting plates
- Framers square
- Loose 8d and 16d sinker nails
- Dunnage for supporting panels
- Expanding foam
- Fall arrest gear for roofs (if applicable)
- Chalk line
- Levels (4' or longer)
- Two 5'–6' 3/4" bar clamps
- Paint scrapers
- Ladders—step & extension
- Come-along with 2" trucking ratchet straps or
- A device similar to Jimmy's Strapjack Panel Puller for pulling panels together
- 1/2" drill motor for 1 1/2" diameter electrical chase holes
- 1 1/2" x 12" auger bit
- 1 or 2 3/8" drill motors
- Chain saw with 14"–16" bar and chain saw guide for site fabrication
- One or two circular saws
- Power planer
- Foam Scoop and/or Avalon hot knife
- Bits for panel screws
- Nail gun or 1/2" crown staple gun
- Reciprocating saw

Spline Connection

Depending on the load requirements and application, Premier Panels are joined together in one of three fashions: Premier spline (Type 'S' panel), lumber spline (double 2x or 3x, Type 'L' panel) or engineered I-joists (Type 'I' panel).

Premier splines – This is the most common connection between Premier Panels. Splines should be cut flush or slightly short (about 1/16") of the foam in the panel ends. Parallel 3/16" dia. beads of Premier Mastic are placed approximately 1/4" from each of the spline edges and a 3/8" dia. bead along the foam-to-foam edges. Premier Mastic is used on all wood-to-wood, wood-to-foam, and foam-to-foam interfaces. Once panels are in place, the splines are nailed with 8d nails 6" o.c. or according to your shop drawing nail pattern.

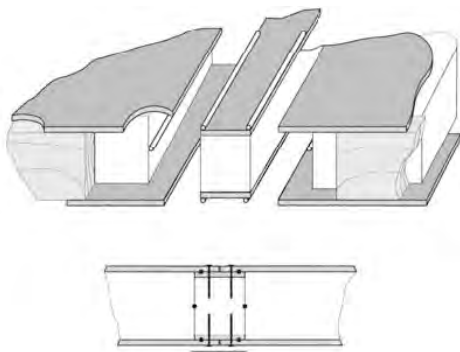

Lumber Connection

Lumber spline – Premier SIPs panels are designed to accept kiln dried lumber set into a standard 1 1/2" recess along the bottom, top, corners and window openings of the panels. Simply cut the plates to length, apply a 3/16" dia. bead of Premier Mastic between plies of the dimensional spline and nail dimensional splines together. Apply a 3/16" dia. bead on each edge of the lumber spline and a 3/8" dia. bead along the center of the recess, set the lumber into the recesses and nail off through the skins with 8d nails 6" o.c. or according to your shop drawings. The lumber should remain flush with the edges of OSB. If your lumber has swelled, it may be necessary to chamfer and trim the piece so it will fit properly. Always dry fit the dimensional lumber before applying Premier Mastic.

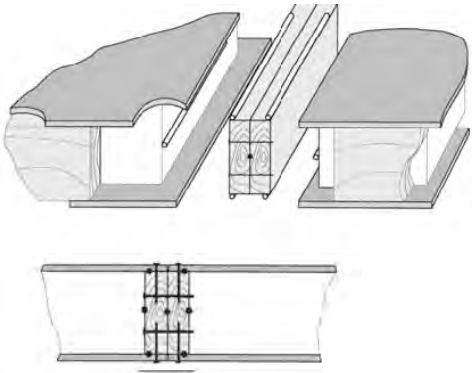

I-Joist Connection

I-Joists – These are mainly used in roof and floor connections. Premier Mastic is applied to the outer edges of the flanges prior to placement in the panel recess. Apply a 3/16" dia. bead on each edge of the lumber spline and a 3/8" dia. bead along the center of the recess.

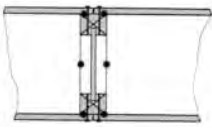
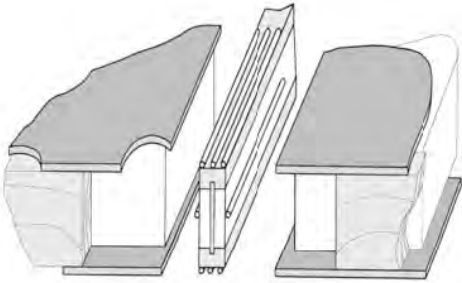

Panel Basics – Assembly

When assembling wall panels, whenever possible, use a scissor-like motion to place the panels. To do this, push the bottom corner so that the skins touch. While holding the top of the panel out about 24" brace your foot on the bottom of the panel, then push the top into place. Be sure to watch your fingers. If you have difficulty getting the panels together, use either trucking straps, bar clamps or dunnage and a sledge hammer with enough force to bring the panels together. Jimmy's Strapjack Panel Puller can also be used to pull the panels together.

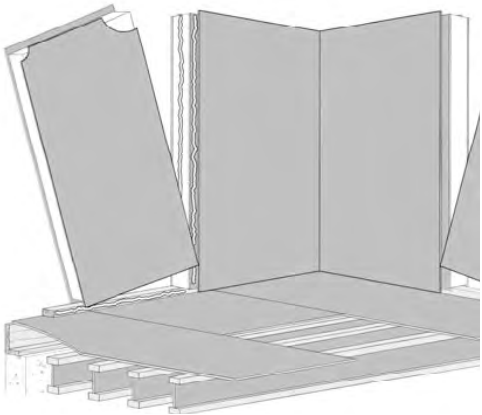

Fasteners

Typically, an 8d nail 6" (o.c.) is used to connect panels to top and bottom plates at spline connections and for dimensional plating. Staples are permitted, provided they meet the following criteria:
Minimum length =
1.5" 14 gauge
@ 6" o.c., 16 gauge
@ 4" o.c.

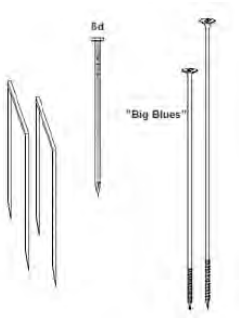

Field Fabrication

Field fabrication will be necessary on the site if you ordered stock panels. Even on factory fabricated panels, slight field modifications may be necessary to allow for panel growth or variations in the actual field dimensions. Modifications are not difficult. Common construction tools will suffice for most projects with the only additional recommended tool being a foam scoop/hot knife (available for purchase) for quick and easy recessing of the foam core.

When performing field modifications to panels, wait to make measurements and modifications until the previous panel has been placed into its final position. When cutting wall panels, make sure you have the correct panel, and that it is PROPERLY ORIENTED (horizontal electrical chases are at the bottom of the panel). Remember to take an extra 1/8" off the desired dimension. We recommend using a pencil to mark your lines on the panel skin, as chalk lines tend to blow off when the saw blade approaches. Metal straight edges can be helpful.

For fast, accurate cuts that are close to a panel edge, use ripping guides for circular saws.

If you are using a circular saw, lay out one face and then square it across the panel skins to transfer your mark to the opposite skin before making your cut. Use the maximum depth of cut setting on your saw and make a nice straight cut. Flip the panel over to layout that side and make a similar cut.

The remaining foam between the panel skins can be cut using a reciprocating saw, or hand saw. When using a reciprocating saw use a dull blade, it will follow the kerf cut in the panel, cutting the foam without slicing the wood.

Scrape off any excess foam between the skins with a metal straight edge such as a speed square. Adjust your foam cutter to the depth of the installed member. (Foam cutters will melt foam back further than the setting, which is just about the right tolerance to get the framing member into the panel.) After your foam is “scooped” out, clean the leftover foam along the sides by placing the foam cutter parallel with the skin. (The depth gauge can rest on the panel edge.) Use a paint scraper or speed square to take off any excess foam that may inhibit lumber placement. Use Premier Mastic as required and follow the appropriate details outlined in this manual or the Premier SIPs detail section of our website at: www.premiersips.com.

Field Fabrication

Rake/Gable Walls

Rake/Gable Walls – are easily calculated and laid out on the panels. First, establish the short side dimension. Next, mark this measurement on both edges. Draw a line horizontally across the panel. The rise across the panel will be determined by your roof pitch. If your panel is 4' wide, multiply the roof pitch by 4' to get your rise (in inches) on the other side of the panel.

For example, a 6:12 pitch will gain 24" (4' x 6" = 24"). An 8:12 pitch has a rise of 32" (4' x 8" = 32") and so on. Again, square across the panel skins prior to making your cut. (Flipping the panel is easier if you layout and cut your panels on a sawhorse.) Recess the foam to the appropriate depth.



Use the long point of one panel to establish the short point of the next adjoining panel. Add a small amount to this measurement to allow for the required 1/8" gap as determined by the roof pitch factor. Continue on to the ridge or highest point. After all rake walls are erected, small adjustments can be made to make the plane of the rake flat: either plane off the high spots on the rake panel skins and re-cut the foam, or just raise the plate slightly to get a straight line along the rake/gable.

Recesses can be melted out of the foam when the foam cutter is placed perpendicular to the skin and the depth gauge is set to 1-1/2". Make sure to blow out the loose foam with an air nozzle or scrape the recess out before installing splines.

ALL FLOOR, WALL AND ROOF PANELS CAN BE FIELD CUT USING THE PRINCIPLES DESCRIBED HEREIN. DIRECT ANY QUESTIONS TO YOUR SALES PROFESSIONAL OR THE PREMIER LOCATION NEAREST YOU.

Floors

Before placing panels, pre-assemble the dimensional lumber, or I-joists, and install them into the edge recesses along the leading edge of the panel. Use 5' bar clamps (if necessary) to help pull twisted lumber flush to the panel edges. Nail both sides of the panel 6" o.c.

Premier splines can be installed as you set each floor panel. They should be placed on the trailing edge of the installed panel. The Premier splines should be placed into the recesses as the panels are being installed. Apply Premier Mastic as described in the connection section.



Use only one nail into each 4' spline to hold it in place. Do not nail off the spline until the next panel is in place. Refer back to the connections section for proper mastic placement.

Before placing the panels on the floor support beams, tack a dry-line spaced 1/2" - 3/4" out from the entire length of the support beam. Use temporary bracing to help hold these beams in place. When setting the panels, make sure the beam stays straight by checking your string line.

Start by placing your first panel on a corner. Use Premier Panel Screws as shown on the shop drawings or described by the engineer of record, to attach the first panel to the supporting beams. Do not tighten the screws on the edges of the panels until your rim board is in place. Also, leave the last two screws on the leading edge loose until you have set your next panel. Once the next panel is in place, screw the previous one tight and repeat the process. Install blocking for point loads per engineered plans as shown above to the right.

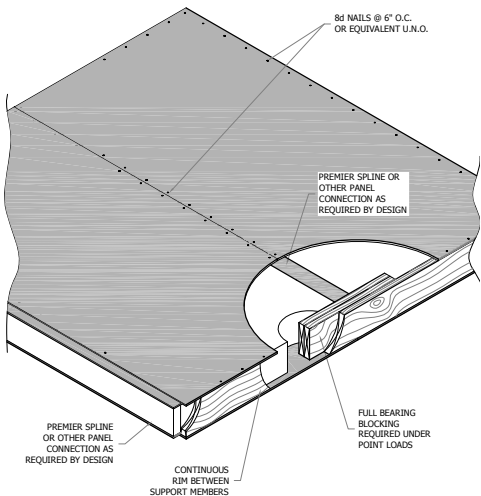

PANEL TIP > Stagger your panel placement with two panels on one side of the beam, four panels on the other side, and four back on the first side of the beam. This will help your beam stay straight.

Assemble floor panels using a scissor action. Use the truck ratchet straps or a device like the Jimmy's Strapjack Panel Puller to help pull panels together as needed, you can also try using blocks of wood and a sledgehammer.

After all the panels are in place, install the rims using Premier Mastic. Refer to Premier SIPs details for the location of the sealant on the rim. Check for proper Panel Screw placement and spacing. Tighten all screws. Make sure to nail off the tops and bottoms of all the floor panel connections as well as the entire perimeter of the floor panels.

Sill Plates

Check your bottom plates to see if they are all the same dimension in width. Install all of the sill plates level ($\pm 1/8"$), square (within a $1/4"$ of being square on the longest diagonal), and to the exact dimensions of the layouts on the shop drawings. When placement of the wall panels is directly on top of a concrete foundation, remember that because the panel skins cannot bear directly on the concrete, a capillary break and solid bearing is required.

One of the best methods to provide a capillary break is to use a treated sill plate that is either equal to the total thickness of the panel or slightly wider.

Take your time and do a good job when you lay out the sill plates. Time spent now will save you time throughout the rest of your project. When you lay out the sill plates, always use the longest building line to establish the base line. Use this base line to establish the largest perpendicular building line available and make it square to the base line. Be exact. Use a calculator or the largest ratio of a 3-4-5 triangle to do this. Measure parallel to either of these reference lines for all other smaller dimensions that are within the structure. Adjust or shift sill plates as required on the foundation system to match all the desired dimensions on the panel layout drawings.

Snap a chalk line on the foundation wall for the inside of the sill plate and begin setting your plates. Use an appropriate sill sealer under the sill plates. Level the plates as required.

If the plates are not laid out to the exact desired dimensions and within 1/8" of level, extensive panel modifications may be required later.

Dimensions for the foundation and sill plates (and the walls that follow) are usually the same as the exterior of the wall panel skins—not the lumber plate that is inside them. This is different from stick framing where the dimensions usually refer to the outside edge of the framing member.

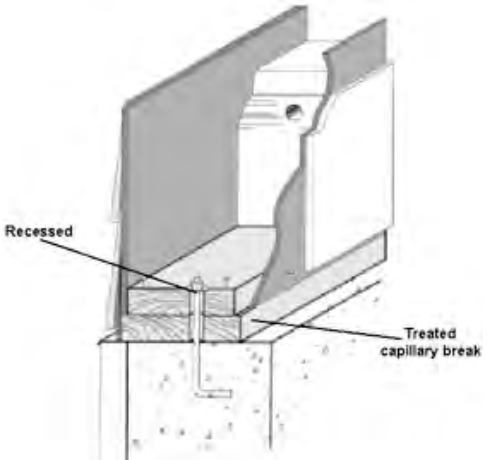

Walls

Time should be spent to organize the job site. Set out the panels in the order you are going to use them. Get all your tools onto the floor deck, including:

- Foam scoop
- Marker
- Flat dolly—for moving panels around the deck (A come-along or truckers ratchet straps is not needed, but may prove useful.)

STEP 1. BOTTOM PLATE

Wall panels are placed over a dimensional bottom plate that fits in the recess in the wall panel. Refer to your panel layout drawings for the location of the bottom plate. The plate will be measured $1/2$ " in from the outside edge of your floor. Snap a chalk line on the floor, equal to the plate width + $1/2$ " to represent the inside edge of the bottom plate. Panel skins should run flush to the floor edge. Apply double $3/8$ " lines of Premier Mastic 1 " from the edge of the plate and nail it off with (3) 16d nails per floor joist or 12 " o.c. to floor system below, or as required by code.

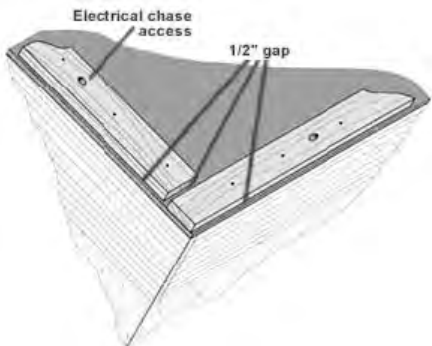

STEP 2. LAYOUT TRANSFER

Using a black marker, transfer the panel layouts to the bottom plate. Include all window and door openings as well as the vertical electrical chases in each wall panel. If electrical chases are being utilized, drill the chase holes as you set each panel using a minimum 1 1/2" bit. (Do not drill all the chase holes down the entire wall, because as panel joints grow you will be off center as you get to the end of the wall.)

STEP 3. PANEL TILT

Determine the best place to start the installation and get your panels to that area. Most of the time it is best to start in a building corner. The corners are locked together using Premier Panel Screws secured through the panel spaced 2' o.c. maximum. (Normally you will use a screw two inches longer than the wall thickness.) Install the screws into the panel close to the lumber plate. Use a drill to finish tightening and the panels will cinch together. Set the underside of the screw heads flush with the OSB, do not break the skin of the panel. Always check the fastening or engineering schedule on your shop drawings.

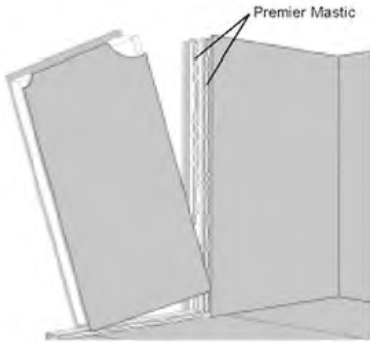

Check the panel dimensions against the floor layout. Apply a 3/8" diameter bead of Premier Mastic along the sides and down the center of the bottom plate. Slide the panel into position. Lift the panel over the bottom plate by using either manpower or mechanical means. After the panel is standing, check for proper placement. Next, plumb the wall section in both directions and fasten it to the plate and the adjacent panel with the specified fasteners. If necessary, brace the wall before moving to the next panel.

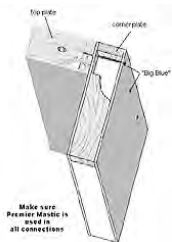

STEP 4. ADJACENT PANEL

Move the next panel into position and apply Premier Mastic in the same manner as with the first panel. On this panel you will run an additional 3/8" diameter bead of mastic down the center of the foam-to-foam interface. Place splines on the floor and run the Mastic down one side and up the other, approximately 1/4" from the edge on the spline.



Set the splines into the grooves of the fixed (standing) panel. Bring your connecting panel into position over the bottom plate, tilted slightly away from the fixed panel. Butt the skins together at the bottom and scissor the walls together using a sharp motion.

STEP 5. FASTENING

Plumb the panel in both directions. It may be necessary to tack the bottom of the panel to hold it in place while the plumbing process takes place. Once the panel is plumb in both directions, nail both sides of the spline seam and the sill plate with 8d nails at 6" o.c. (You may have to brace the wall.)

STEP 6. TOP PLATE

Repeat the procedures for the remaining wall panels. When you get to a corner or opening make sure to check the panel dimensions before standing the panel. (This panel may need to be trimmed to fit the location properly.)



After all of the walls are up, prior to setting your top plate, check and plumb the alignment of each wall, getting as close to square and plumb as possible. If electrical chases are being utilized, mark the vertical chases onto your dimensional lumber top plate. Cut the top plate so that the ends of the top plate have a minimum 2' overlap with the wall panel seams. Apply a 3/8" diameter bead of Premier Mastic down the center and along each edge of the wall panel recess. Set the top plate and nail it off according to the engineering specs, (usually 8d nails 6" o.c.) finish by drilling the electrical chase access with a minimum 1 1/2" auger bit.

Headers

Depending on the engineering requirements of your windows and doors, Premier's Insul-Beam II can be used in place of double 2 x 12s in spans up to 16'.

Determine trimmer height: depth of the header + the top plate + bottom plate - height of panel = height of trimmer ($11 \frac{1}{4}" + 1 \frac{1}{2}" + 1 \frac{1}{2}" - 96" = 81 \frac{3}{4}"$). Cut your trimmer and cripple, apply Premier Mastic and nail them together. Slide the pieces into the panel recess. Next, install the panel that sits below the window. Put your trimmer and cripple into this panel. Set the

next panel into place over the bottom plate and tip it into its final position.

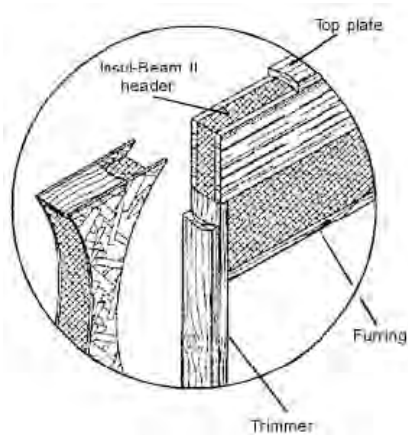

Measure the total depth of the header required and add any sheathing or plating to the top or bottom of the header to achieve this dimension. Measure the maximum length the header can be and cut the header 1/8" short of this, taking care to avoid the nails in the Insul-Beam II as you cut.

Apply Premier Mastic to the insides of the opening and drop the Insul-Beam II horizontally into place. Do not nail the panel skins to this header yet. Apply Premier Mastic to the top of the panel, down the center of the Insul-Beam II and inside both ends.

Cut your panel top plate to be continuous over the opening and at least 1' past each end of the opening and 1' from any panel joint. Install the top plate into the panel recess and over the header. Nail the top plate to the Insul-Beam II first with 2 16d nails 12" o.c. Nail the panel skins on either side of the header to the top plate first then down the sides of the panels along the Insul-Beam II.

FIGURE 14 - PBS DETAIL #25

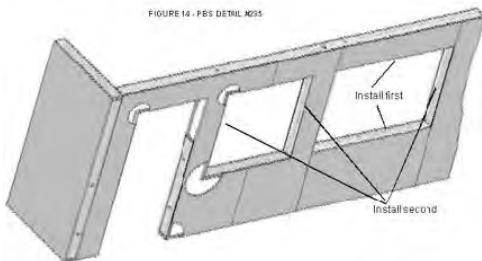

Fur out both sides of the Insul-Beam II with 7/16" sheathing to match the thickness of the panels, keeping the sheathing flush with the top of the top plate.

Intermediate Floors

PLATFORM FRAMING

In typical platform framing, the rim is placed on top of the panel, flush to the exterior, and the joists are placed on top of the panel.

(Floor joists can be either engineered wood or dimensional lumber. For more information, refer to the "Floor" section of this guide and the Premier SIPs detail section of our website at www.premiersips.com)



**Make sure
Premier Mastik is used in
all connections**

Another option: Once the top plate is in, you may now also hang joists directly from the wall panel. Use a joist hanger with a nailable top flange. The flange should bear at least 1.5" (2" is best) on to the top plate. Nail the top flange following the fastening schedule specified by the engineer.

As always, consult with your engineer of record concerning your specific design requirements.

Roofs



Upon receiving your roof panels, count them and check the sizes. In most cases roof panels are not fabricated at the factory because roofs tend to vary from the shop drawings. If they have been factory fabricated, double check for accuracy. Also, check the edge treatment. You may have to plane your lumber or I-joists to fit the recesses. If the panels aren't being installed immediately, cover the panels and lumber until ready for installation.

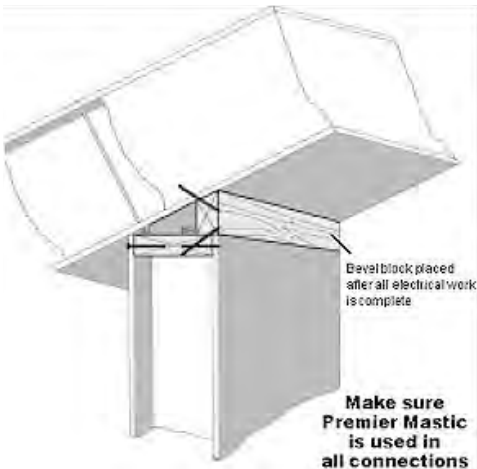

ON THE GROUND

Prior to lifting, install as many of your dimensional lumber splines and I-joist splines as possible along the connecting sides of each roof panel. Premier splines should be installed as panels are installed. The dimensional lumber at the ridge and eaves should be installed after the panels are set in place. (If panels are perpendicular to the ridge.)

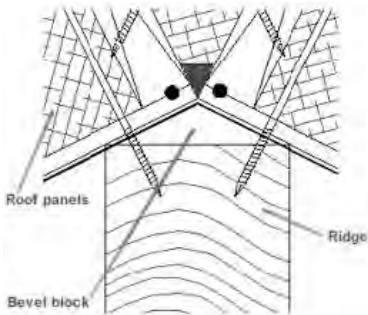

Cut a bevel block out of dimensional lumber to the same pitch as the roof and fasten the full length of the ridge. The roof panel must bear at least 1 1/2" on the beveled block. Next, tack SIP Tape that is 18" wide on top of the ridge beam. (Be sure that the release paper is facing up towards the underside of the roof panels.)

LIFTING PANELS

Use either a picking eye or strap method to lift your roof panels. (A lifting apparatus can be fashioned from a 4" eye made from 3/4" steel rod.) The shaft should be at least 14" long. The nut should be tack welded to a minimum 4" diameter washer made of 1/2" thick steel.



Use a lifting plate that is 12"x12"x3/16" with a 4x5 grid of holes to attach screws through and into the OSB skin of the panels. (The plate should have a "U" welded to it to fasten the lifting device to.) A minimum of two plates should be used to lift each panel.

Determine the center of each panel. Depending on the pitch of the roof, drill your hole for the picking eye, or place the center of the two lifting plates, 3" from the center of the panel toward the ridge end for every pitch change after 4:12. For example: On a 7:12 roof, the lifting hole will be 9" from the panel center. This will allow the panel to arrive on the ridge at almost the proper pitch, which will help the panel installation. If you use the picking eye, be sure to fill the hole with expanding foam sealant prior to installing roofing felt. (If the roof panel has installed lumber, the placement of the lifting eye or plates may need to be adjusted.)

During the install, it is recommended that you alternate the placement of the panels on either side of the ridge beam. Start with two panels on one side of the ridge, then four on the other side. To help prevent the ridge beam from bowing, alternate this sequence for the balance of the roof. To make placement of adjacent panels easier, do not fasten the last screw tightly at the ridge or eave of the leading panel edge, as it may become difficult to place the next panel due to compression from the last screw.

In some wall/roof connections, as shown on the previous page, the electrician can run the wires in the void created by the beveled block. Once the wires are in place, spray expanding foam in the void or use an EPS wedge infill.

Valley Connections – Premier Panels can be used in hips and valleys. Consult with your Premier Sales Professional and the Premier Detail manual for more information.

Ridge Cap – Begin by trimming off 1/2" from the bottom of the ridge cap point. Spray a high-yield, expanding foam into the bottom and along the sides of the ridge and set the ridge cap in place. Adhere two strips of OSB to the top of the ridge using Premier Mastic and Panel Screws.

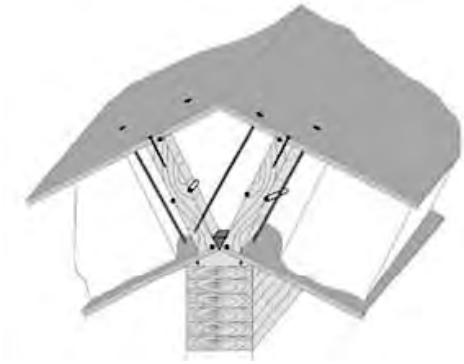

Vapor Retarder – An appropriate vapor retarder must be installed on the interior of the roof panels. Premier recommends using SIP tape on the panel joints and at the wall to roof connections. Refer to Technical Bulletin #28 at www.premiersips.com for more information on this subject.

Insul-Lam

Insul-Lam is used as a non-structural nail base in either a one or two layer system.

Two-Layer System – Begin by installing the 2x dimensional lumber dam around the perimeter of the roof. The height of the dam is determined by the depth of Insul-Lam being installed. In residential applications, Premier SIPs recommends the use of a vapor retarder with either the one or two layer systems. You will need to cut one 2' x 4' foam section and enough 2' x 8' foam sections from your shipment to ring the perimeter flush to your lumber dam.

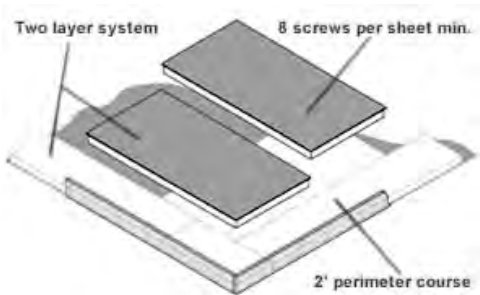

Once the 2' sections are in place, layout the remaining 4' x 8' foam sheets.

Top Layer – Apply the nail base top layer perpendicular to the foam layer so that joints overlap. You will need to remove 1 1/2" of foam along the edges of your perimeter course so the OSB overlaps your lumber dam. Once an Insul-Lam top sheet is in position, fasten the assembly to the deck with Premier Panel Screws following the spacing and frequency determined by engineering. Penetrate the structural deck to a depth of at least 1". Along the perimeter fasten

the OSB into the 2x lumber with 8d nails 6" o.c. or according to the engineers requirements.

Where vapor retarders are required they should be applied before the installation of the Insul-Lam panels. Roof cladding and/or finish materials should be installed according to the manufacturer's specifications and recommendations.

Electrical

GENERAL GUIDELINES

Never cut long grooves in the skin of a panel. Long grooves in the skin can seriously compromise the structural integrity of your panels. When necessary, you may cut 4" access holes and use a long remodelers flex bit with a catch hook to run wires where a chase may not exist.



Use vertical chases and interior walls whenever possible for most of your wiring needs.

Use a remodeler's box that has flanges so the box can be fastened directly to the panel skin.

Push or pull all wires through a chase simultaneously. With an electrician's pliers fold and crimp the longest wire back on itself about 1". Wrap electrical tape around that end. Stagger remaining wires flat side to flat side and tape these to the long wire below the crimp. Have 8"-10" of straight wire to slide into the electrical chase holes.

As a general rule, don't try to go horizontal between outlets or switches in the panels unless the distance is short and you have no other options. Use the vertical chases to run the wire back into the floor or attic if the roof is stick framed. The triangular space on top of the wall panel and under the roof panel can be used as a chase if SIPs are used for the walls and roof. Refer to detail PBS-301. Run the wires horizontally in these areas to access the vertical chases in the panels.

To gain access to chase intersections, use a 4" to 4 1/8" hole saw. Use a flat blade screw driver and pry out the plug. Nail the plug to the wall for reinstallation. After pulling your wires, secure the plug with Premier Mastic or expanding foam.



Where walls terminate against a panel you can drill (at the horizontal electrical chase height) a long diagonal hole through the face of the stud diagonally into the electrical chase. Electrical wires will stuff easily into this type of access.

Plumbing

Whether you are building a standard stick frame house or a panel home, Premier does not recommend placing plumbing chases in the exterior walls. This eliminates the possibility for condensation and frozen pipes.

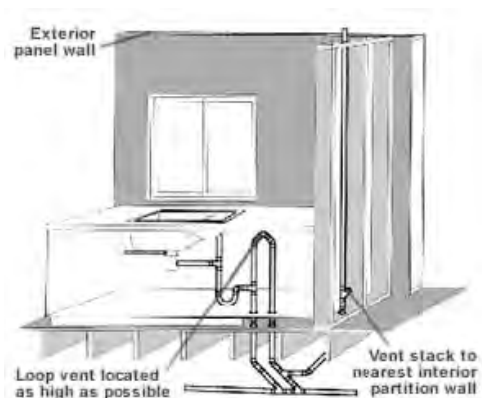

Situations do arise in which it becomes necessary for a builder to consider options for chases in the exterior walls such as a kitchen sink next to a window or washer and dryer unit next to an exterior wall. This situation can be answered through the use of an “island vent” through the floor to the nearest interior wall.

Another possible solution is to use an Air Admittance Valve (AAV). AAV's are one-way valves that allow air into the vent stack without requiring the vent stack to extend to the exterior of the building. An example of an AAV can be found at www.studor.com. Consult your local building code for proper design.

Shearwalls

A shearwall is a vertical bracing element that transfers the in-plane forces imposed on a floor or roof diaphragm to the foundation. Wood framed buildings use shearwalls as the vertical bracing element or lateral load resisting element almost exclusively. The most common way to anchor panels is to measure and cut out an access plate in the panel wall adjacent to the tension post. Allow enough room to maneuver the holdown and 2x blocking.

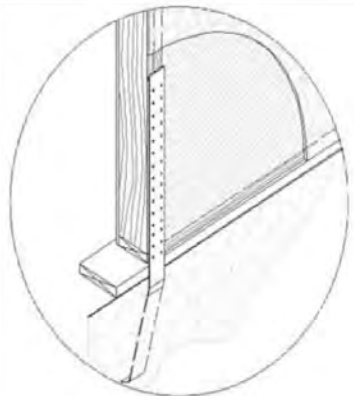
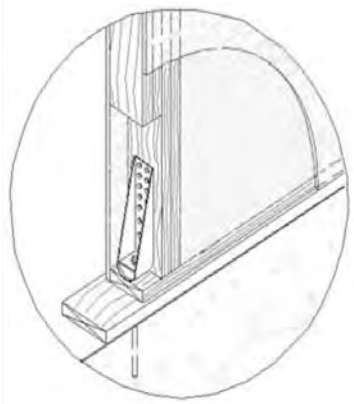

Premier Panel R-Values

Type I modified EPS core

Core Thickness	R-Value at 75°	R-Value at 40°	R-Value at 25°
3-1/2"	15	16	17
5-1/2"	23	25	26
7-1/4"	30	32	33
9-1/4"	37	40	42
11-1/4"	45	49	51

Panel Weight (Psf)

Type I modified EPS core

Core Thickness	OSB Skin Thickness				
	3/8"	7/16"	1/2"	5/8"	3/4"
3-1/2"	2.9	3.3	3.8	4.6	5.5
5-1/2"	3.1	3.5	4.0	4.8	5.7
7-1/4"	3.3	3.7	4.1	5.0	5.9
9-1/4"	3.4	3.9	4.3	5.2	6.1
11-1/4"	3.6	4.0	4.5	5.4	6.2

Axial Load Chart 1: Allowable Axial Loads (plf) for Premier Type S (Spline) SIPs

Panel Core Thickness	Wall Panel Height (ft.)							
	8'	10'	12'	16'	20'	24'		
3 1/2"	3500	2553	2452	NA	NA	NA		
5 1/2"	4250	4042	3373	3358	NA	NA		
7 1/4"	4917	4325	4473	4194	3496	NA		
9 1/4"	4200	4200	4200	4200	3389	NA		
11 1/4"	3890	3890	3890	3890	3890	NA		

Axial loads represent ultimate load divided by a safety factor of 3.

Loads do not reflect secondary effect of P_A

More information on this chart can be found in Technical Bulletin #4



Axial Load Chart 2: Allowable Axial Loads (plf) for Premier Type L (Lumber) SIPs

Panel Core Thickness	Wall Panel Height (ft.)					
	8'	10'	12'	16'	20'	24'
3 1/2"	4723	3903	3094	2350	NA	NA
5 1/2"	5849	5889	4278	4311	NA	NA
7 1/4"	6850	6111	5556	5181	4835	NA
9 1/4"	5470	5470	5470	5470	5470	4250
11 1/4"	4500	4333	4167	3750	3750	3333

Axial loads represent ultimate load divided by a safety factor of 3.

Loads do not reflect secondary effect of $P\Delta$

2x's are spaced 4' on center.

More information on this chart can be found in Technical Bulletin #4

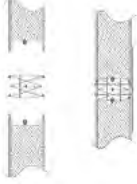

Panel Core Thickness	Deflection	Panel Span (ft.)										
		4'	8'	10'	12'	14'	16'	18'	20'	22'	24'	
9 1/4"	L/360	138	78	64	53	41	33	27	22	20	17	
	L/240	160*	86*	65*	57*	51*	46*	41	34	29	25	
	L/180	160*	86*	65*	57*	51*	46*	42*	39*	37*	34	
11 1/4"	L/360	115	94*	75	51	49	47	38	28	24	21	
	L/240	160*	94*	76*	59*	55*	51*	45*	39*	36	31	
	L/180	160*	94*	76*	59*	55*	51*	45*	39*	36*	33*	



* indicates ultimate load divided by 3 for the design capacity.
 4' span is a minimum two span condition.
 Panels require a minimum of 1-1/2" bearing.
 Floor panels should have a 3/4" minimum top skin or a 7/16" top skin overlaid with 7/16" finish flooring perpendicular to the panels.
 More information on this chart can be found in Technical Bulletin #18 (www.premiersips.com).
 Refer to Technical Bulletin #21 for floor applications (www.premiersips.com).

**Transverse Load Chart 4:
Premier SIPs Type L (Lumber)
Transverse Load Chart (psf)**

Panel Core Thickness	Deflection	Panel Span (ft.)													
		4'	8'	10'	12'	14'	16'	18'	20'	22'	24'				
3 1/2"	L/360	98	45	32	24	16	11								
	L/240	225	67	47	34	24	16	NA	NA	NA	NA	NA	NA	NA	NA
	L/180	298*	90	61	44	34	22								
5 1/2"	L/360	241	128	57	41	32	25	20	15						
	L/240	288*	182*	86	60	49	37	29	22	NA	NA	NA	NA	NA	NA
	L/180	288*	182*	112*	79	65	49	39	29						
7 1/4"	L/360	241	168	80	65	54	42	33	24						
	L/240	288*	188*	126	99	81	61	49	34	NA	NA	NA	NA	NA	NA
	L/180	288*	188*	133*	117*	105	80	62	44						

Maximum Floor Span Maximum Roof Span



Panel Core Thickness	Deflection	Panel Span (ft.)										
		4'	8'	10'	12'	14'	16'	18'	20'	22'	24'	
9 1/4"	L/360	274	188*	116	100	80	58	47	36	32	28	
	L/240	326*	188*	147*	134*	120	90	70	52	46	41	
	L/180	326*	188*	147*	134*	121*	108*	93	68	61	53	
11 1/4"	L/360	327*	188*	167*	140	116	90	75	57	47	36	
	L/240	327*	188*	167*	153*	132*	110*	97*	83*	69	53	
	L/180	327*	188*	167*	153*	132*	110*	97*	83*	83*	70	



* indicates ultimate load divided by 3 for the design capacity.

2X's are Hem-Fir #2 or equivalent.

4' span is a minimum two span condition.

Panels require a minimum of 1-1/2" bearing

Lumber splines are spaced 4' o.c.

Floor panels should have a 3/4" minimum top skin or a 7/16" top skin overlaid with 7/16" finish flooring perpendicular to the panels.

More information on this chart can be found in Technical Bulletin #19 (www.premiersips.com).

Refer to Technical Bulletin #21 for floor applications (www.premiersips.com).

Transverse Load Chart 5: Premier SIPs Type I (I-Joist) Transverse Load Chart (psf)

Panel Core Thickness	Deflection	Panel Span (ft.)											
		4'	8'	10'	12'	14'	16'	18'	20'	22'	24'		
7 1/4"	L/360	132	136	93	60	48	40	29	21				
	L/240	318*	148*	107*	91	70	54	42	31		NA		
	L/180	318*	148*	107*	92*	85	54	48	40				
9 1/4"	L/360	197	164*	124*	72	66	61	48	34				
	L/240	318*	164*	124*	107*	96*	84*	70	49		43		
	L/180	318*	164*	124*	107*	96*	84*	76*	65		56		
11 1/4"	L/360	258	143*	103*	86	83	77*	61	42				
	L/240	318*	143*	103*	93*	85*	77*	68*	59*		54*		
	L/180	318*	143*	103*	93*	85*	77*	68*	59*		54*		49*

* indicates ultimate load divided by 3 for the design capacity.

4' span is a minimum two span condition.

Panels require a minimum of 1-1/2" bearing.

I-Joist splines are spaced 4' o.c.

Floor panels should have a 3/4" minimum top skin or a 7/16" top skin overlaid with 7/16" finish flooring perpendicular to the panels.

More information on this chart can be found in Technical Bulletin #13 (www.premiersips.com).

Refer to Technical Bulletin #21 for floor applications (www.premiersips.com).

Maximum Floor Span



Maximum Roof Span



Load Chart 6

Point Load Design Values on Premier Wall SIPs

	1 1/2" min. bearing width	3" min. bearing width
Standard Detail	2040 lbs.	2450 lbs.
Additional Cap Plate	4030 lbs.	4678 lbs.

More information on this chart can be found in PBS Technical Bulletin #2 (www.premiersips.com).

Refer to PBS Detail-010 for cap plate detail (www.premiersips.com)



Load Chart 7: Allowable Header Loads (plf) Condition 1-Panel is Continuous Over Opening (No Splines)

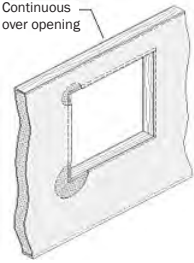

Header Depth	Deflection	Header Span (ft.)			
		4'	6'	8'	10'
12"	L/480	740*	385*	229*	142*
	L/360	740*	385*	229*	142*
	L/240	740*	385*	229*	142*
18"	L/480	798*	574*	385*	311*
	L/360	798*	574*	385*	311*
	L/240	798*	574*	385*	311*
24"	L/480	886*	629*	429*	361*
	L/360	886*	629*	429*	361*
	L/240	886*	629*	429*	361*

* indicates ultimate load divided by 3 for the design capacity.
In all cases where a concentrated load is placed over an opening or the design loads exceed the capacity of a panel header, Premier Insul-Beam II should be used if possible or an engineered header assembly is required.
More information on this chart can be found in Technical Bulletin #10 (www.premiersips.com).

Load Chart 8: Allowable Header Loads (plf) Condition 2–Panel is Not Continuous Over Opening (Splines)

SIPs wall panel
spline minimum
6" from edge
of opening

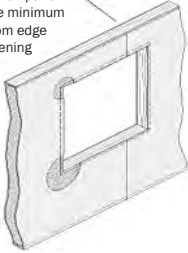

Header Depth	Deflection	Header Span (ft.)			
		4'	6'	8'	10'
12"	L/480	345	243	156	99
	L/360	450	295	190	125
	L/240	630	382	236*	153*
18"	L/480	705	388	254	235
	L/360	750*	482	302*	281*
	L/240	750*	482	302*	281*
24"	L/480	698	582*	368*	350*
	L/360	895*	582*	368*	350*
	L/240	895*	582*	368*	350*

* indicates ultimate load divided by 3 for the design capacity.
In all cases where a concentrated load is placed over an opening or the design loads exceed the capacity of a panel header, Premier Insul-Beam II should be used if possible or an engineered header assembly is required.
More information on this chart can be found in Technical Bulletin #10 (www.premiersips.com).

Load Chart 9: Premier Insul-Beam II Header Loads (plf)

No. of Trimmer Studs	Deflection	Header Span (ft.)						
		2'	3'	4'	5'	6'	7'	8'
1	L/480	3150	2100	1575	1260	1050	900	788
	L/360	3150	2100	1575	1260	1050	900	788
	L/240	3150	2100	1575	1260	1050	900	788
2	L/480	6300	4200	3150	2520	2100	1800	1545
	L/360	6300	4200	3150	2520	2100	1800	1575
	L/240	6300	4200	3150	2520	2100	1800	1575



No. of Trimmer Studs	Deflection	Header Span (ft.)								
		9'	10'	11'	12'	13'	14'	15'	16'	
1	L/480	700	630	573	458	360	288	234	193	
	L/360	700	630	573	525	480	384	313	257	
	L/240	700	630	573	525	485	450	420	386	
2	L/480	1085	791	594	458	360	288	234	193	
	L/360	1400	1055	792	610	480	384	313	257	
	L/240	1400	1245	792	864	720	577	469	386	

Values listed for each deflection represent the least value of the bearing capacity of the trimmer, shear or bending capacity of the header or the actual deflection at the design load.

Refer to Technical Bulletin #30 for supporting headers in Premier SIPs wall panels (www.premiersips.com).

Note: Trimmer stud design capacities must be reviewed.

Load Chart 10A: Premier Wall SIPs^{1,2} Maximum Allowable Shear Wall Loads

Panel Type	Minimum OSB Face Thickness	Attachments				Shear (plf)
		2x Framing		Splines		
		Fasteners	Spacing	Fasteners	Spacing	
L or S	7/16"	8d box nail	6 inches	8d nail	6 inches	300
S	7/16"	8d box nail	4 inches	#6 screw ³	4 inches	600 ⁴

1. Framing lumber shall be a minimum of SPF #2 having a minimum specific gravity of 0.43.
2. The maximum panel height-to-width ratio shall be 3.5:1
3. Screws are #6 x 1-1/4 inch Type W drywall screws.
4. Two top plates are required.

Load Chart 10B: Premier Wall SIPs^{1,2} Maximum Allowable Shear Wall Loads

Panel Type	Minimum OSB Face Thickness	Attachments				Shear (plf)
		Top Plate	Bottom Plate	Vertical Framing	Splines ⁵	
L or S	7/16"	8d box nail 6" OC	8d box nail 6" OC	8d box nail 6" OC - 2 rows ⁴	8d box nail 6" OC	470
L or S	7/16"	8d box nail 4" OC - 2 rows ³	8d box nail 4" OC	8d box nail 4" OC - 2 rows ⁴	8d box nail 4" OC	700
L or S	7/16"	10d box nail 6" OC - 2 rows ³	10d box nail 3" OC	10d box nail 6" OC - 2 rows ⁴	10d box nail 3" OC - 2 rows	1010

1. Framing lumber shall be a minimum of SPF #2 having a minimum specific gravity of 0.43.

2. The maximum panel height-to-width ratio shall be 3.5:1

3. A double top plate is required.

4. A double stud or nominal 4x framing member is required.

5. Splines are 7/16" by 3" OSB.

Load Chart 11: Premier SIPs¹ Maximum Allowable Diaphragm Loads

Minimum OSB Face Thickness	Attachments						Shear (plf)
	Panel Supports		Panel Joints - Top Only		Panel Joints - Top & Bottom		
	Fasteners	Spacing	Fasteners	Spacing	Fasteners	Spacing	
7/16"	PBS Screw ²	12 inches	8d nail	3 inches	8d nail	6 inches	425
7/16"	PBS Screw ²	3 inches	8d nail	2 inches	8d nail	4 inches	510
7/16"	PBS Screw ²	4 inches	8d nail - 2 rows	3 inches	8d nail - 2 rows	6 inches	917
23/32"	PBS Screw ²	4 inches	8d nail - 2 rows	3 inches	8d nail - 2 rows	6 inches	1136

1. The maximum panel height-to-width ratio shall be 4.5:1.

2. Premier SIPs specially-designed big screws.

Load Chart 12: Wind Speed vs. Pressure (Chart 1 of 2)

Wall Loads (psf) - End Zone (Zone 5) for 100sf to 500 sf effective wind area												
Mean Roof Height (ft)	90 MPH			100 MPH			110 MPH			120 MPH		
	Exp B	Exp C	Exp D	Exp B	Exp C	Exp D	Exp B	Exp C	Exp D	Exp B	Exp C	Exp D
15	-15.1	-18.3	-22.2	-18.7	-22.6	-27.5	-22.6	-27.3	-33.2	-26.9	-32.5	-39.5
20	-15.1	-19.5	-23.4	-18.7	-24.1	-29.0	-22.6	-29.2	-35.0	-26.9	-34.7	-41.7
25	-15.1	-20.4	-24.3	-18.7	-25.2	-30.1	-22.6	-30.5	-36.4	-26.9	-36.3	-43.3
30	-15.1	-21.1	-25.1	-18.7	-26.2	-31.0	-22.6	-31.6	-37.5	-26.9	-37.7	-44.7
35	-15.9	-21.9	-25.7	-19.6	-27.1	-31.8	-23.7	-32.8	-38.4	-28.2	-39.0	-45.7
40	-16.5	-22.5	-26.3	-20.4	-27.9	-32.5	-24.6	-33.7	-39.3	-29.3	-40.1	-46.8
45	-16.9	-23.1	-26.9	-20.9	-28.6	-33.3	-25.3	-34.6	-40.2	-30.1	-41.2	-47.9
50	-17.5	-23.6	-27.3	-21.7	-29.2	-33.8	-26.2	-35.3	-40.9	-31.2	-42.0	-48.7
55	-18.0	-24.0	-27.8	-22.3	-29.7	-34.4	-26.9	-35.9	-41.6	-32.0	-42.8	-49.5
60	-18.4	-24.5	-28.2	-22.8	-30.3	-35.0	-27.6	-36.6	-42.3	-32.8	-43.6	-50.3
Net Design wind pressure	-15.1			-18.7			-22.6			-26.9		

More information on this chart can be found in Technical Bulletin #15 (www.premiersips.com).

Load Chart 12: Wind Speed vs. Pressure (Chart 2 of 2)

Wall Loads (psf) - End Zone (Zone 5) for 100sf to 500sf effective wind area												
Mean Roof Height (ft)	130 MPH			140 MPH			150 MPH			170 MPH		
	Exp B	Exp C	Exp D	Exp B	Exp C	Exp D	Exp B	Exp C	Exp D	Exp B	Exp C	Exp D
15	-31.6	-38.2	-46.5	-36.7	-44.4	-53.9	-42.1	-50.9	-61.9	-54.1	-65.5	-79.5
20	-31.6	-40.8	-49.0	-36.7	-47.3	-56.9	-42.1	-54.3	-65.3	-54.1	-69.8	-83.9
25	-31.6	-42.7	-50.9	-36.7	-49.5	-59.1	-42.1	-56.8	-67.8	-54.1	-73.0	-87.1
30	-31.6	-44.2	-52.5	-36.7	-51.4	-60.9	-42.1	-58.9	-69.9	-54.1	-75.7	-89.8
35	-33.2	-45.8	-53.7	-38.5	-53.2	-62.4	-44.2	-61.1	-71.6	-56.8	-78.4	-92.0
40	-34.4	-47.1	-55.0	-40.0	-54.7	-63.9	-45.9	-62.7	-73.3	-59.0	-80.6	-94.1
45	-35.4	-48.3	-56.2	-41.1	-56.2	-65.3	-47.2	-64.4	-74.9	-60.6	-82.8	-96.3
50	-36.7	-49.3	-57.2	-42.6	-57.3	-66.4	-48.8	-65.7	-76.2	-62.8	-84.4	-97.9
55	-37.6	-50.2	-58.1	-43.7	-58.4	-67.5	-50.1	-66.9	-77.5	-64.4	-86.0	-99.5
60	-38.6	-51.2	-59.1	-44.8	-59.5	-68.6	-51.4	-68.2	-78.7	-66.0	-87.6	-101.2
Net Design wind pressure	-31.6			-36.7			-42.1			-54.1		

More information on this chart can be found in Technical Bulletin #15 (www.premiersips.com).

PREMIER SIPS



STRUCTURAL INSULATED PANELS

BY **INSULFOAM** A **CARLISLE** Company

Stronger. Straighter. Greener.

Corporate Insulfoam Office

6004 N. Westgate Blvd.
Ste 120
Tacoma, WA 98406

Regional Field Offices

Northwest

19041 80th Ave. S.
Kent, WA 98032
TF 800-275-7086
T 206.242.9424
F 425.251.8405

Southwest

1155 Business Park Dr.
Building A
Dixon, CA 95620
T 707-678-6900
F 707-678-2962

Central

270 Foss Flats Rd.
Belgrade, MT 59714
T 406-388-5553
F 406-388-5557

Technical Center

17001 Fish Point Rd.
#101
Prior Lake, MN 55372
800-469-8870

Website: premiersips.com

Email: info@premiersips.com

Toll Free: 800-275-7086